

F

E

D

C

B

A

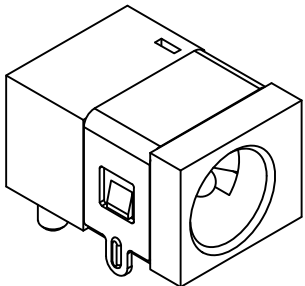

RoHS
Compliant

ZONE	SYMBOL	REVISION	APPROVAL	DATE

1

1

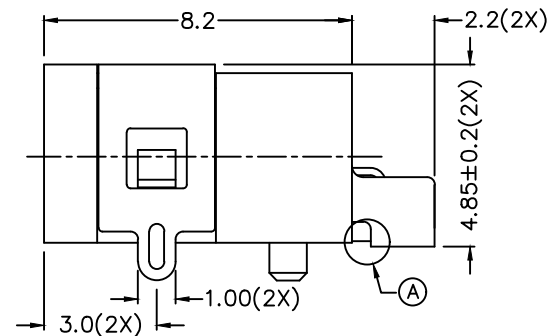
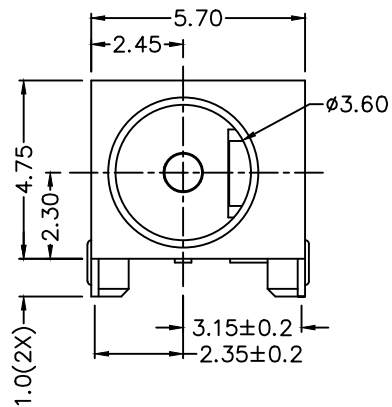
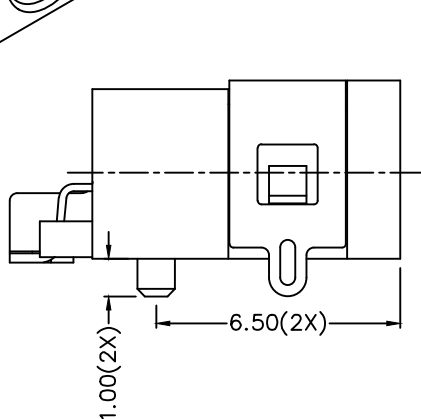

2

2

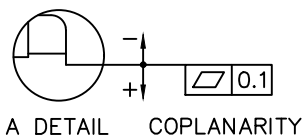
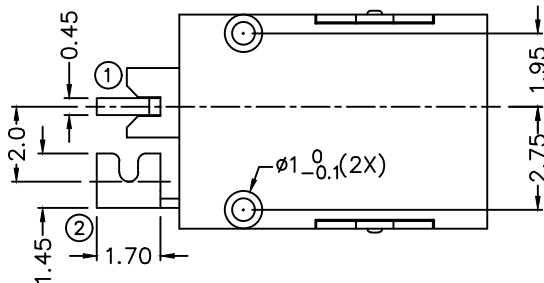

*** MATERIAL**

TERMINAL 1 : COPPER ALLOY
 TERMINAL 2 : COPPER ALLOY
 SHIELD : BRASS
 HOUSING : HIGH TEMP. PLASTIC

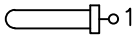
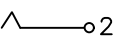
MODEL NO.	LDC-070DS
SCHEMATIC	 1
	 2
CENTER PIN	ø1.000mm

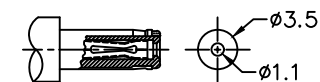
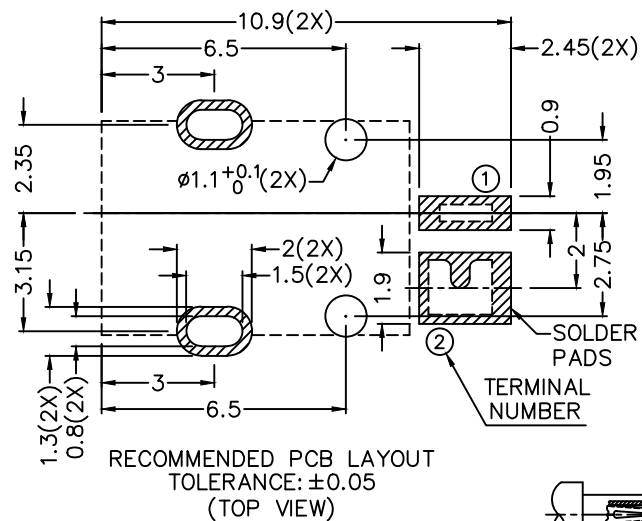

RECOMMENDED
 DC MATING PLUG

3

3

4

4



LINKPLEX TECHNOLOGY LIMITED

PART NAME	SMD DC POWER SOCKET	TOLERANCE UNLESS	0.0±0.2	UNIT:	
PART NO.	LDC-070DS	OTHERWISE SPECIFIED:	0.00±0.1 0.000±0.05	mm	

DESIGN	G.P.YI	DATE	5-7-2007	SCALE	5:1
DRAWING	Y.J.GUO	DATE	22-7-2024	MATERIAL	*
CHECK	T.Y.LI	DATE	22-7-2024	DWG. NO.	TZ\DC070DS-A/2.0
APPROVAL	H.Q.ZHOU	DATE	22-7-2024	SHEET	1/1

F

E

D

C

B

A